

# EGE Linea Led





EGE is floor standing luminaire range with on/off, 1-10V knob dim and 1-10V touch dim options. It is an ideal solution for many applications including houses, office lighting, schools, libraries etc. 2700K, 3000K, 3500K, 4000K and 5000K alternatives available.

EGE ayaklı yer lambası serisi on/off, 1-10V anahtar dim ve 1-10V touch dim seçenekleri ile ev, ofis, okul, kütüphane vb alanlarda tercih edilir. 2700K, 3000K, 3500K, 4000K ve 5000K seçenekleri mevcuttur.

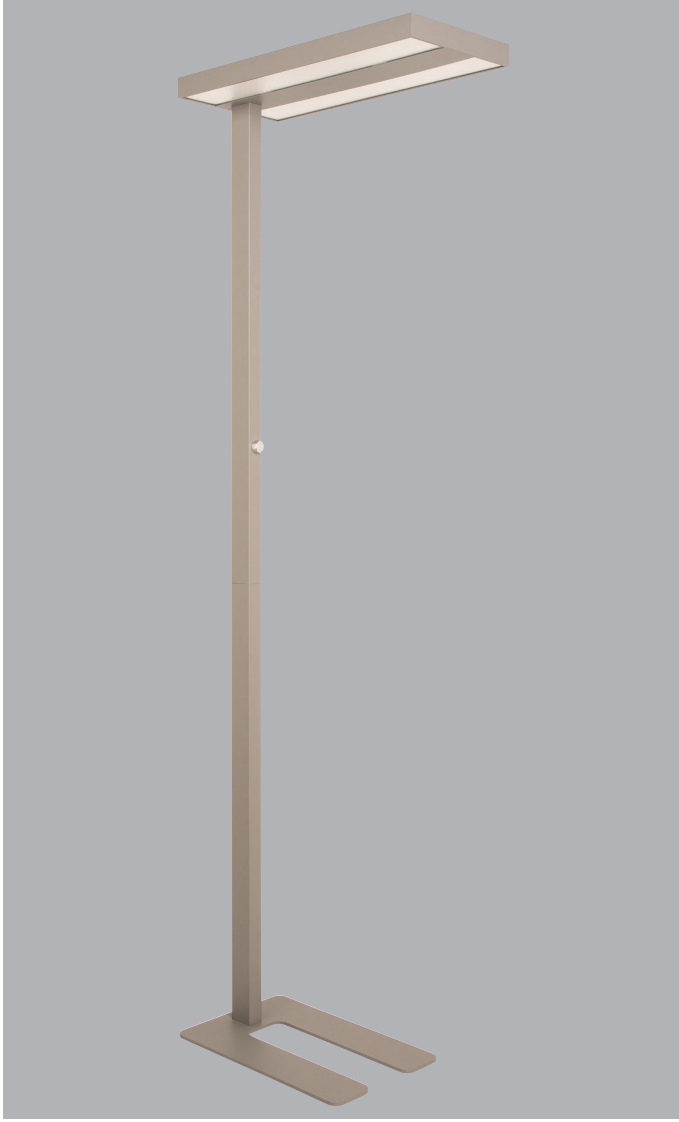

## Technical Drawing / Teknik Çizim

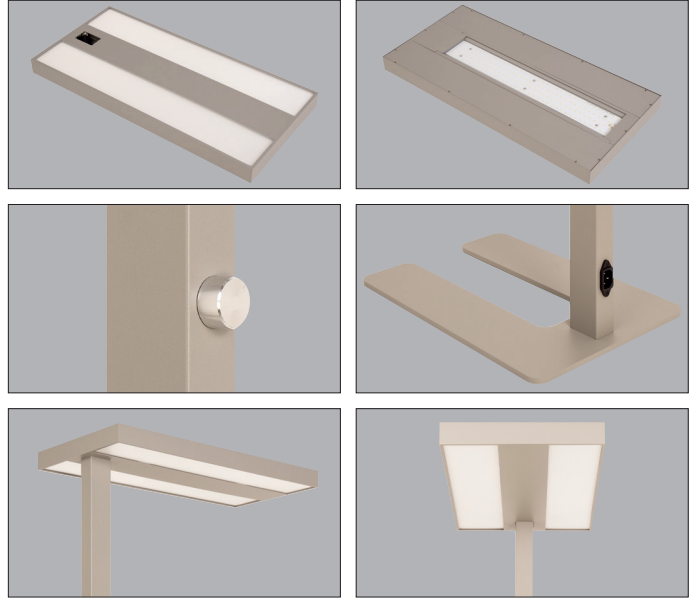
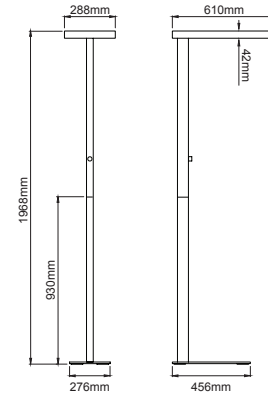

## 4 / Product Color / Ürün Renk



## Beam Angle / Işık Açısı



Product Data / Armatür Data	
Item No / Ürün Kod	I02.LL.90205.060.830.01
Family Name / Aile Adı	Ege
Material / Malzeme	Aluminium Profile / Alüminyum Profil
Installation Type / Kurulum Türü	Floor Standing / Ayaklı Yer Lambası
Efficiency / Verimlilik	>130lm/W
CRI	80
Light Distribution / Işık Dağılımı	Symmetric Wide Flood / Simetrik Geniş Açılı
Protection Rating / Koruma Sınıfı	40
Lifetime / Armatür Ömrü	L70 / B50 50000 h
Optic / Optik	Opal Diffuser / Opal Pleksi

## Ege / 102.LL.90205



\* Code example / Kod örneği:

102.LL.90205 . 060 . 830 . 01  
 1 2 3 4

- 1- Product code / Armatür kodu
- 2- Power / Güç
- 3- CRI / Kelvin
- 4- Colour / Ürün renk
- 5- Control type / Kontrol tipi

Watt	CRI	Order Code / Sipariş Kodu	Kelvin	30W lm ↓	30W lm ↑
60W	CRI>80	102.LL.90205 . (...) . (...) . (...) . (...)	2700K	3675	3675
			3000K	3745	3745
			3500K	3825	3825
			4000K	3900	3900
			5000K	4015	4015
60W	CRI>90	102.LL.90205 . (...) . (...) . (...) . (...)	2700K	3420	3420
			3000K	3485	3485
			3500K	3555	3555
			4000K	3625	3625

2 Watt	Watt - Driving Current / Watt - Sürüş Akımı		3 CRI / Kelvin		4 Product Color / Ürün Renk	
	60W	30W 30W	30W (Direct) 30W (Indirect)	827 CRI>80 - 2700K 830 CRI>80 - 3000K 835 CRI>80 - 3500K 840 CRI>80 - 4000K 850 CRI>80 - 5000K	927 CRI>90 - 2700K 930 CRI>90 - 3000K 935 CRI>90 - 3500K 940 CRI>90 - 4000K	01 white 02 ral 9010 03 black 04 gray 05 dark gray 06 special color

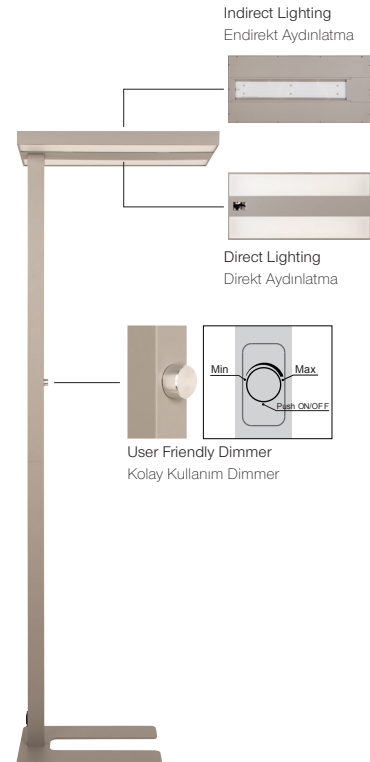

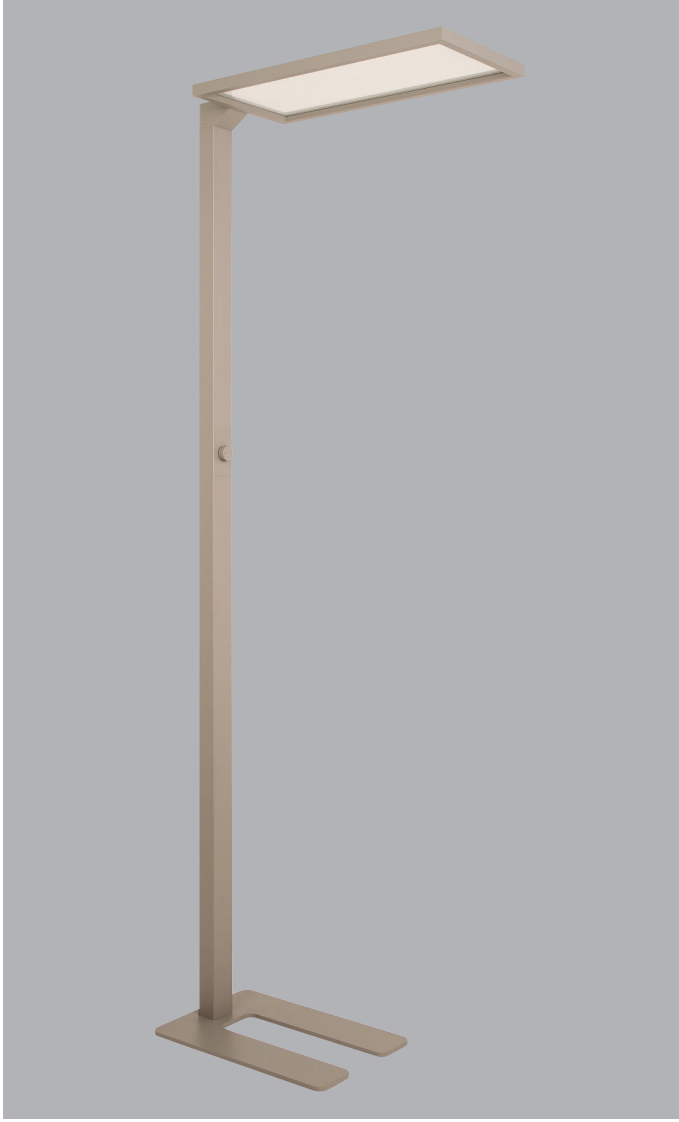

## Technical Drawing / Teknik Çizim

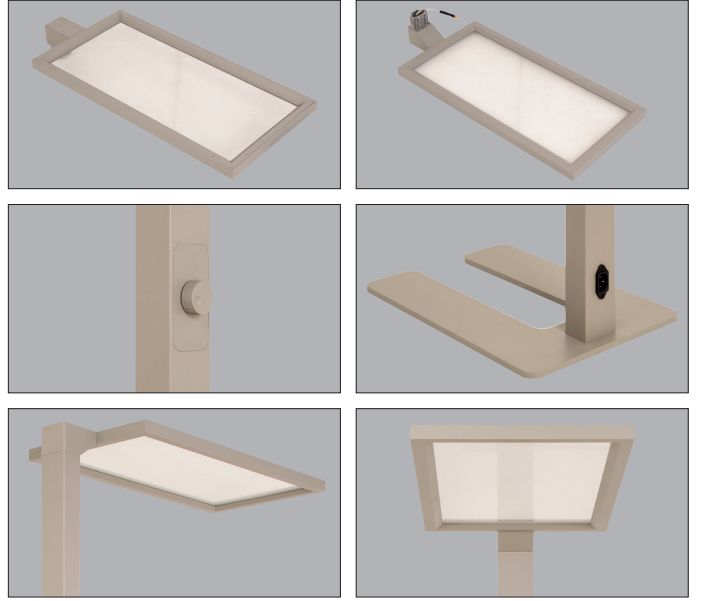
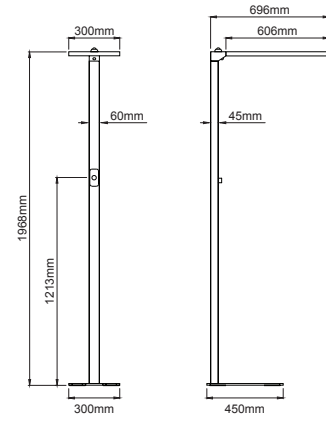

## 4 / Product Color / Ürün Renk



## Beam Angle / Işık Açısı



Product Data / Armatür Data	
Item No / Ürün Kod	I02.LL.90210.070.830.01
Family Name / Aile Adı	Ege
Material / Malzeme	Aluminium Profile / Alüminyum Profil
Installation Type / Kurulum Türü	Floor Standing / Ayaklı Yer Lambası
Efficiency / Verimlilik	>120lm/W
CRI	80
Light Distribution / Işık Dağılımı	Symmetric Wide Flood / Simetrik Geniş Açılı
Protection Rating / Koruma Sınıfı	40
Lifetime / Armatür Ömrü	L70 / B50 50000 h
Optic / Optik	LGP Transparent Diffuser / LGP Transparan Pleksi

## Ege / 102.LL.90210

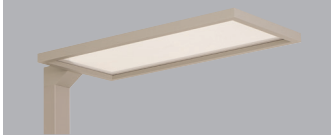

\* Code example / Kod örneği:

102.LL.90210 . 070 . 830 . 01  
 1 2 3 4

- 1- Product code / Armatür kodu
- 2- Power / Güç
- 3- CRI / Kelvin
- 4- Colour / Ürün renk
- 5- Control type / Kontrol tipi

Watt	CRI	Order Code / Sipariş Kodu	Kelvin	35W lm ↓	35W lm ↑
70W	CRI>80	102.LL.90210 . (...) . (...) . (...) . (...)	2700K	3950	3950
			3000K	4035	4035
			3500K	4115	4115
			4000K	4200	4200
			5000K	4325	4325
70W	CRI>90	102.LL.90210 . (...) . (...) . (...) . (...)	2700K	3675	3675
			3000K	3750	3750
			3500K	3825	3825
			4000K	3900	3900

2	Watt	Watt - Driving Current / Watt - Sürüş Akımı		3		CRI / Kelvin		4		Product Color / Ürün Renk	
		35W	35W	35W (Direct)	35W (Indirect)	827	CRI>80 - 2700K	927	CRI>90 - 2700K	01	white
(...) / Complete Code / Komple Kod	70W	35W	35W	35W (Direct)	35W (Indirect)	830	CRI>80 - 3000K	930	CRI>90 - 3000K	02	ral 9010
						835	CRI>80 - 3500K	935	CRI>90 - 3500K	03	black
						840	CRI>80 - 4000K	940	CRI>90 - 4000K	04	gray
						850	CRI>80 - 5000K			05	dark gray
										06	special color

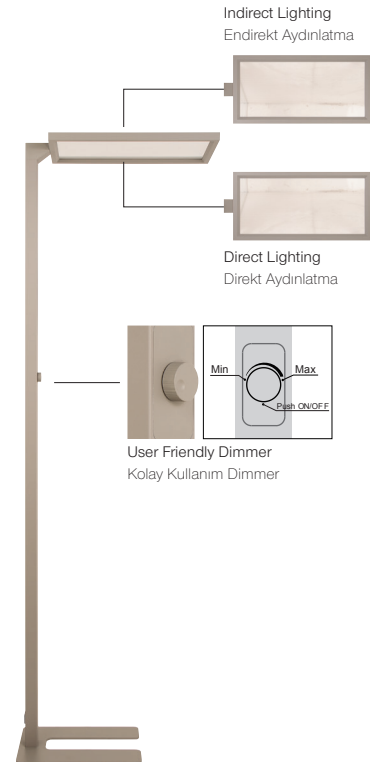

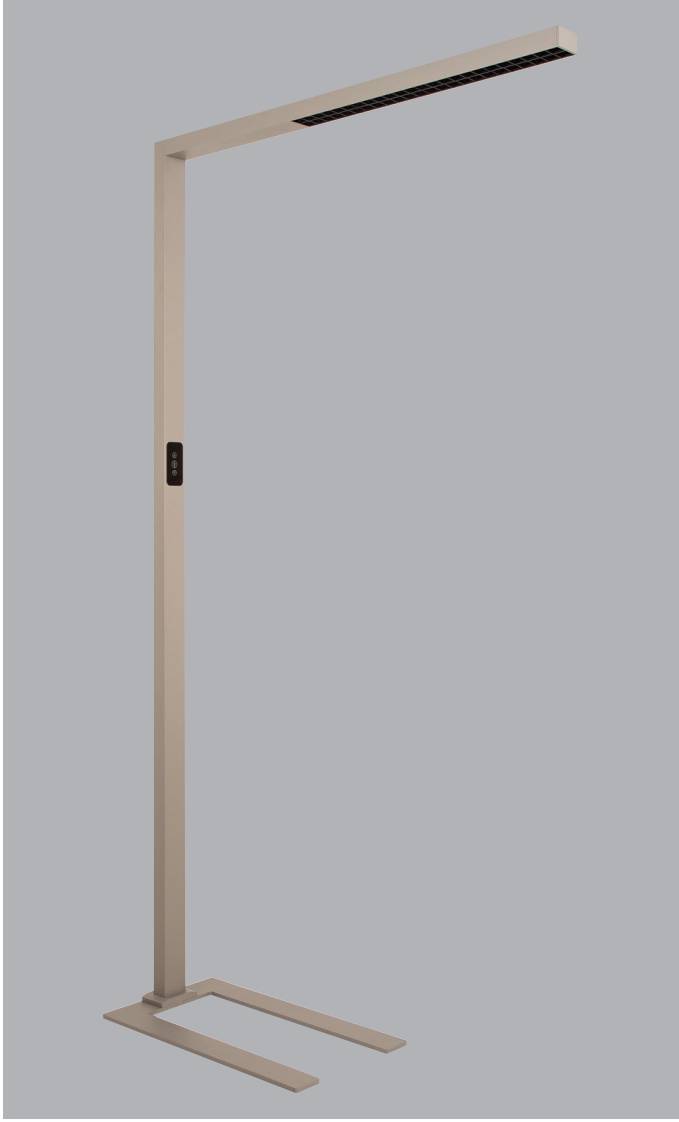

## Technical Drawing / Teknik Çizim

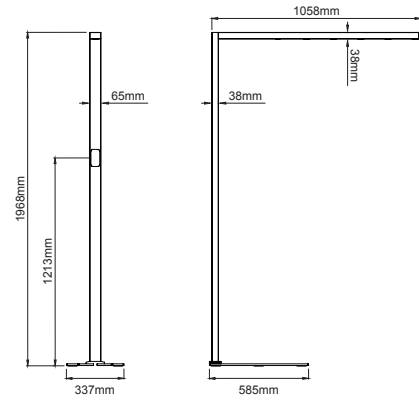

### 4 / Product Color / Ürün Renk



### Beam Angle / Işık Açısı



Product Data / Armatür Data	
Item No / Ürün Kod	I02.LL.90215.060.830.01
Family Name / Aile Adı	Ege
Material / Malzeme	Aluminium Profile / Alüminyum Profil
Installation Type / Kurulum Türü	Floor Standing / Ayaklı Yer Lambası
Efficiency / Verimlilik	>130lm/W
CRI	80
Light Distribution / Işık Dağılımı	Symmetric Wide Flood / Simetrik Geniş Açılı
Protection Rating / Koruma Sınıfı	40
Lifetime / Armatür Ömrü	L70 / B50 50000 h
Optic / Optik	Direct side Lens optic Indirect side opal diffuser / Direkt tarafı lens optik indirekt tarafı opal pleksi

## Ege / 102.LL.90215



\* Code example / Kod örneği:

102.LL.90215 . 060 . 830 . 01  
 1 2 3 4

- 1- Product code / Armatür kodu
- 2- Power / Güç
- 3- CRI / Kelvin
- 4- Colour / Ürün renk
- 5- Control type / Kontrol tipi

Watt	CRI	Order Code / Sipariş Kodu	Kelvin	20W lm ↓	40W lm ↑
60W	CRI>80	102.LL.90215 . (...) . (...) . (...) . (...)	2700K	2160	5175
			3000K	2205	5285
			3500K	2250	5390
			4000K	2300	5500
			5000K	2370	5665
60W	CRI>90	102.LL.90215 . (...) . (...) . (...) . (...)	2700K	2010	4810
			3000K	2050	4905
			3500K	2090	5000
			4000K	2135	5100

2 Watt	Watt - Driving Current / Watt - Sürüş Akımı		3 CRI / Kelvin		4 Product Color / Ürün Renk	
	60W	20W 40W	20W (Direct) 40W (Indirect)	827 CRI>80 - 2700K 830 CRI>80 - 3000K 835 CRI>80 - 3500K 840 CRI>80 - 4000K 850 CRI>80 - 5000K	927 CRI>90 - 2700K 930 CRI>90 - 3000K 935 CRI>90 - 3500K 940 CRI>90 - 4000K	01 white 02 ral 9010 03 black 04 gray 05 dark gray 06 special color

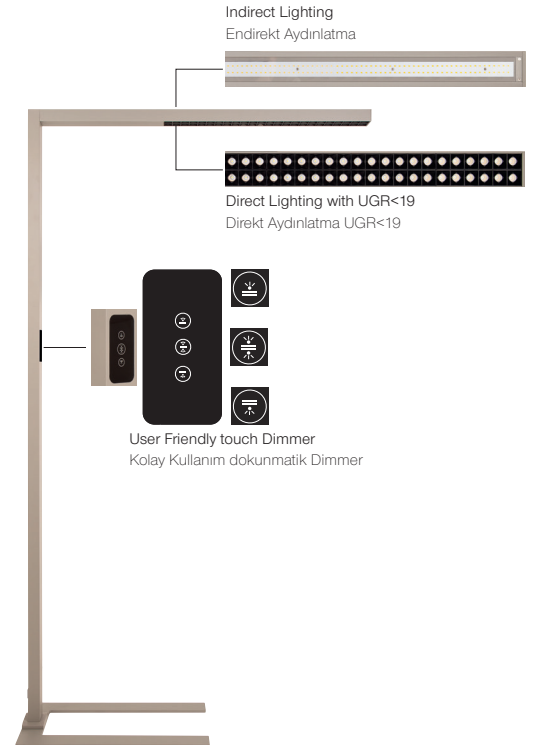

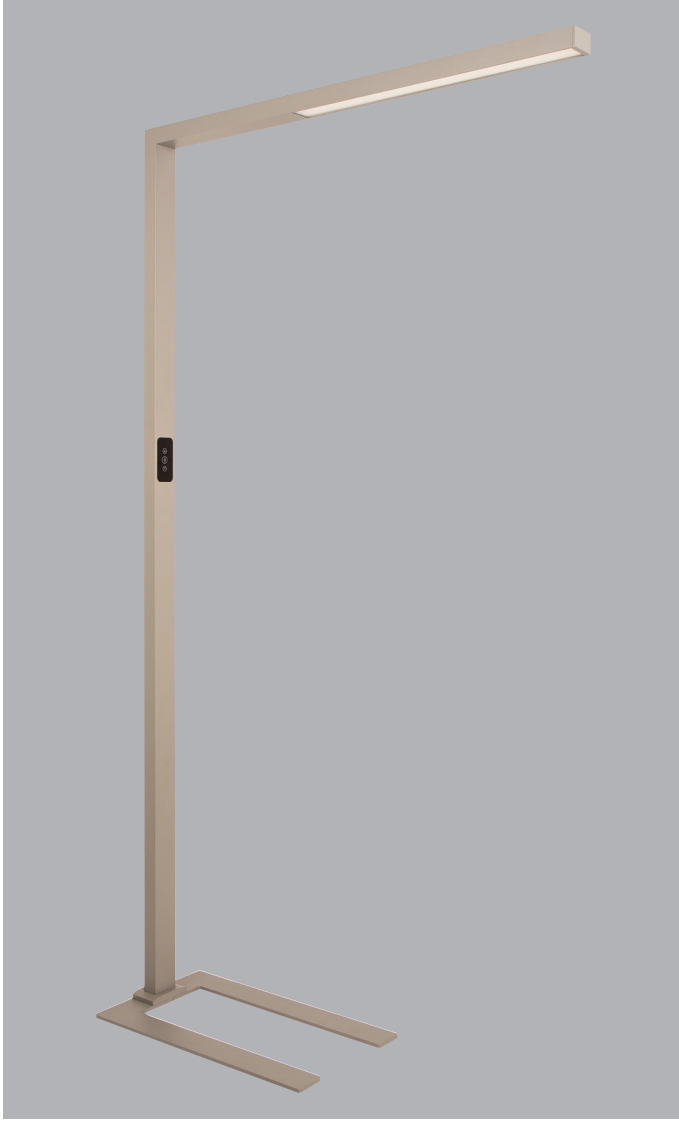

## Technical Drawing / Teknik Çizim

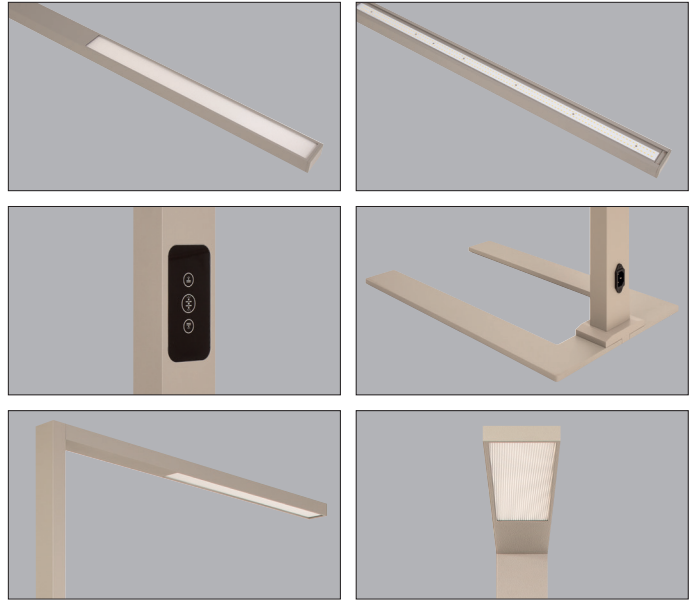
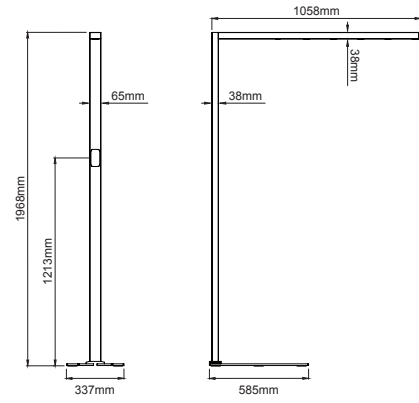

### 4 / Product Color / Ürün Renk



### Beam Angle / Işık Açısı



Product Data / Armatür Data	
Item No / Ürün Kod	I02.LL.90220.060.830.01
Family Name / Aile Adı	Ege
Material / Malzeme	Aluminium Profile / Alüminyum Profil
Installation Type / Kurulum Türü	Floor Standing / Ayaklı Yer Lambası
Efficiency / Verimlilik	>130lm/W
CRI	80
Light Distribution / Işık Dağılımı	Symmetric Wide Flood / Simetrik Geniş Açılı
Protection Rating / Koruma Sınıfı	40
Lifetime / Armatür Ömrü	L70 / B50 50000 h
Optic / Optik	Opal Diffuser / Opal Pleksi

## Ege / 102.LL.90220



\* Code example / Kod örneği:

102.LL.90220 . 060 . 830 . 01

1 2 3 4

- 1- Product code / Armatür kodu
- 2- Power / Güç
- 3- CRI / Kelvin
- 4- Colour / Ürün renk
- 5- Control type / Kontrol tipi

Watt	CRI	Order Code / Sipariş Kodu	Kelvin	30W lm ↓	30W lm ↑
60W	CRI>80	102.LL.90220 . (...) . (...) . (...) . (...)	2700K	3675	3675
			3000K	3745	3745
			3500K	3825	3825
			4000K	3900	3900
			5000K	4015	4015
60W	CRI>90	102.LL.90220 . (...) . (...) . (...) . (...)	2700K	3420	3420
			3000K	3485	3485
			3500K	3555	3555
			4000K	3625	3625

2 Watt	Watt - Driving Current / Watt - Sürüş Akımı		3 CRI / Kelvin		4 Product Color / Ürün Renk	
	60W	30W 30W	30W (Direct) 30W (Indirect)	827 CRI>80 - 2700K 830 CRI>80 - 3000K 835 CRI>80 - 3500K 840 CRI>80 - 4000K 850 CRI>80 - 5000K	927 CRI>90 - 2700K 930 CRI>90 - 3000K 935 CRI>90 - 3500K 940 CRI>90 - 4000K	01 white 02 ral 9010 03 black 04 gray 05 dark gray 06 special color

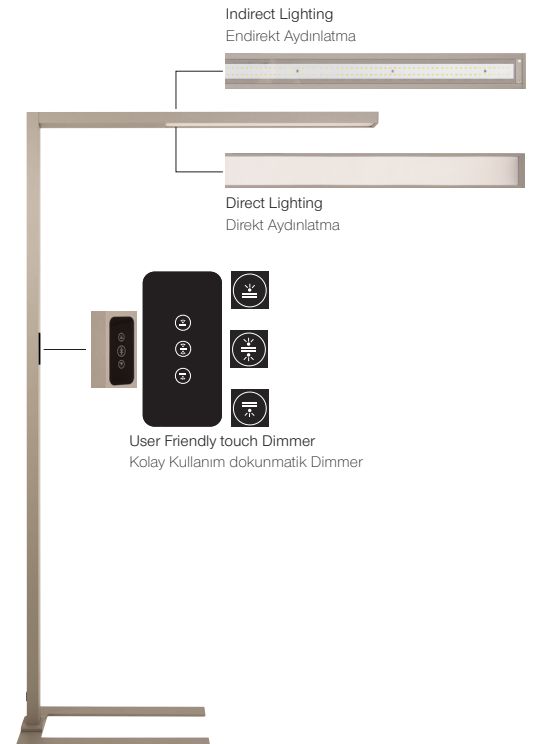

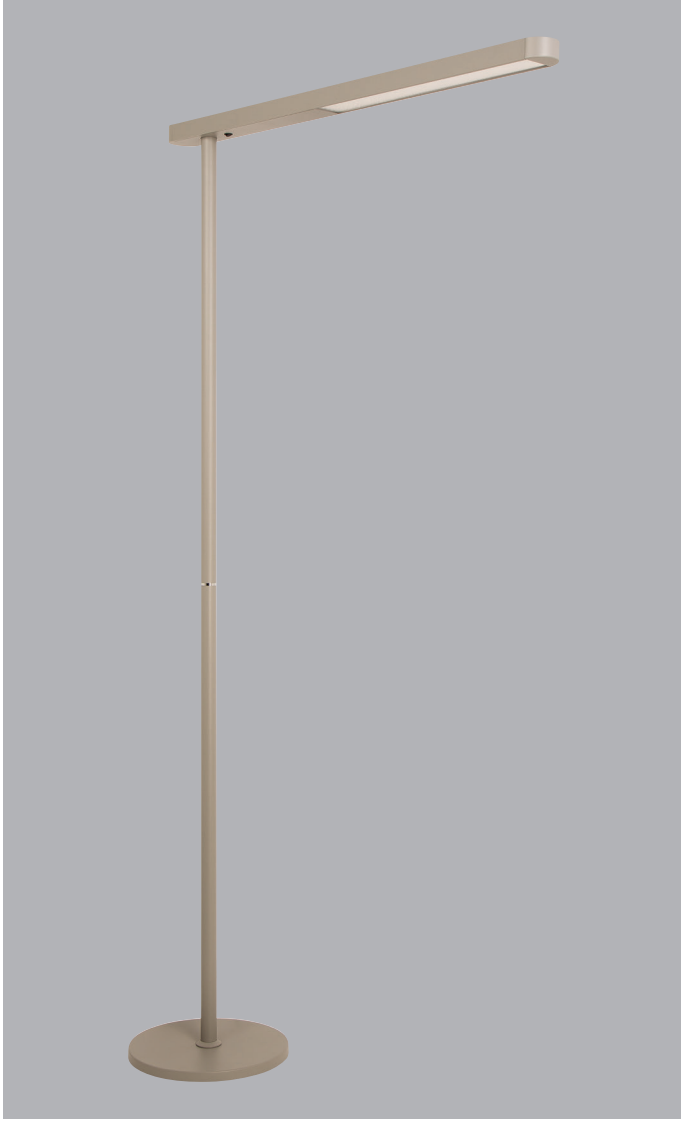

## Technical Drawing / Teknik Çizim

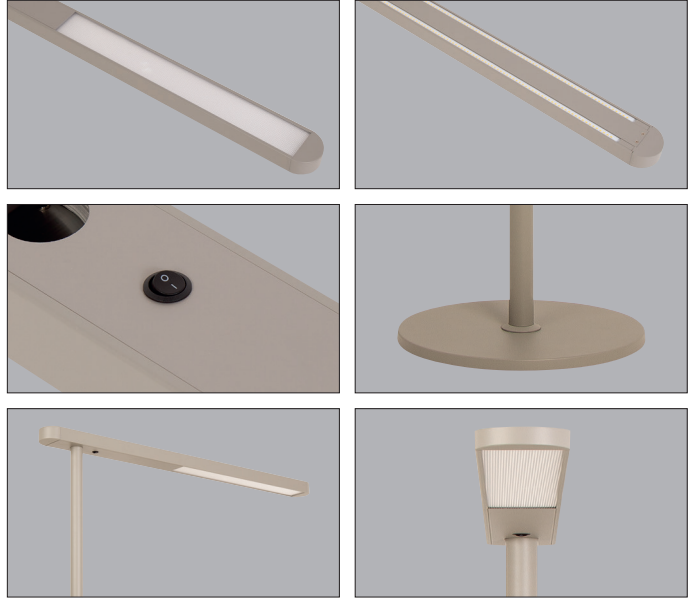
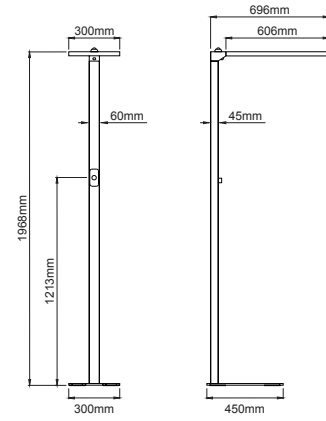

## 4 / Product Color / Ürün Renk



## Beam Angle / Işık Açısı



Product Data / Armatür Data	
Item No / Ürün Kod	I02.LL.90225.040.830.01
Family Name / Aile Adı	Ege
Material / Malzeme	Aluminium Profile / Alüminyum Profil
Installation Type / Kurulum Türü	Floor Standing / Ayaklı Yer Lambası
Efficiency / Verimlilik	>130lm/W
CRI	80
Light Distribution / Işık Dağılımı	Symmetric Wide Flood / Simetrik Geniş Açılı
Protection Rating / Koruma Sınıfı	40
Lifetime / Armatür Ömrü	L70 / B50 50000 h
Optic / Optik	Opal Diffuser / Opal Pleksi

## Ege / 102.LL.90225



\* Code example / Kod örneği:

102.LL.90225 . 040 . 830 . 01  
 1 2 3 4

- 1- Product code / Armatür kodu
- 2- Power / Güç
- 3- CRI / Kelvin
- 4- Colour / Ürün renk
- 5- Control type / Kontrol tipi

Watt	CRI	Order Code / Sipariş Kodu	Kelvin	16W lm ↓	24W lm ↑
40W	CRI>80	102.LL.90225 . (...) . (...) . (...) . (...)	2700K	1960	2935
			3000K	2000	2995
			3500K	2040	3060
			4000K	2080	3120
			5000K	2140	3215
CRI>90	102.LL.90225 . (...) . (...) . (...) . (...)	2700K	1820	2730	
		3000K	1860	2785	
		3500K	1895	2840	
		4000K	1935	2900	

2 Watt	Watt - Driving Current / Watt - Sürüş Akımı		3 CRI / Kelvin		4 Product Color / Ürün Renk	
	40W	16W 24W	16W (Direct) 24W (Indirect)	827 CRI>80 - 2700K 830 CRI>80 - 3000K 835 CRI>80 - 3500K 840 CRI>80 - 4000K 850 CRI>80 - 5000K	927 CRI>90 - 2700K 930 CRI>90 - 3000K 935 CRI>90 - 3500K 940 CRI>90 - 4000K	01 white 02 ral 9010 03 black 04 gray 05 dark gray 06 special color

